

LIGHTPLANE 6 - LPL6

Suspended
Wall
Surface

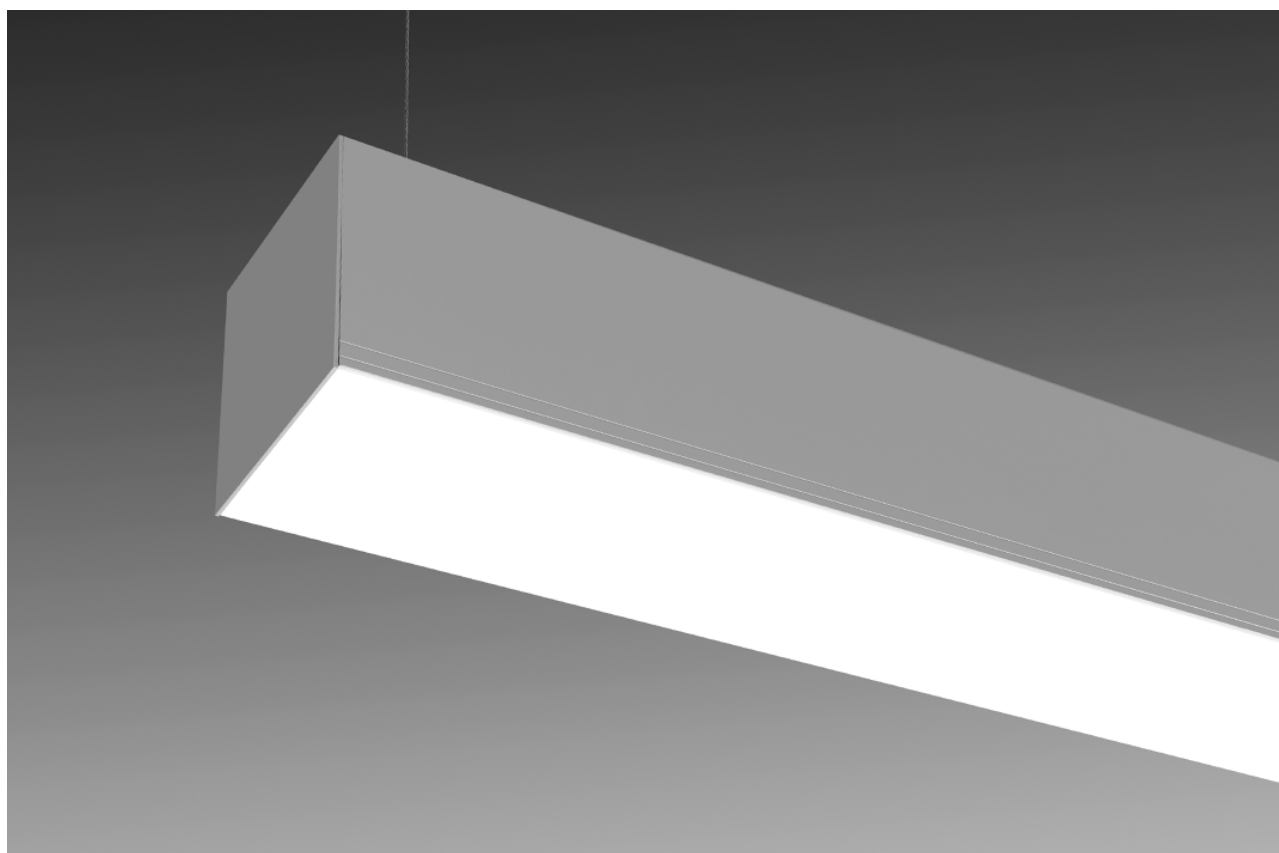

LIGHTPLANE 6 — LPL6

Suspended, Wall, Surface

ZALITE



LIGHTPLANE 6 — LPL6

Suspended, Wall, Surface

ZALITE

Dimensions

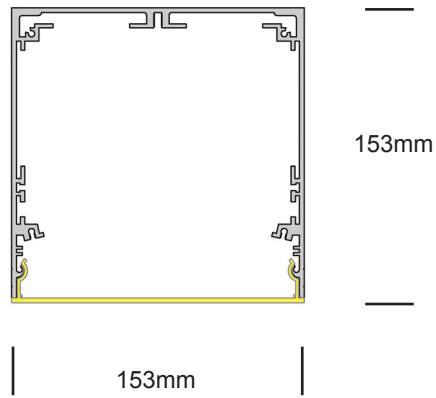

Distribution

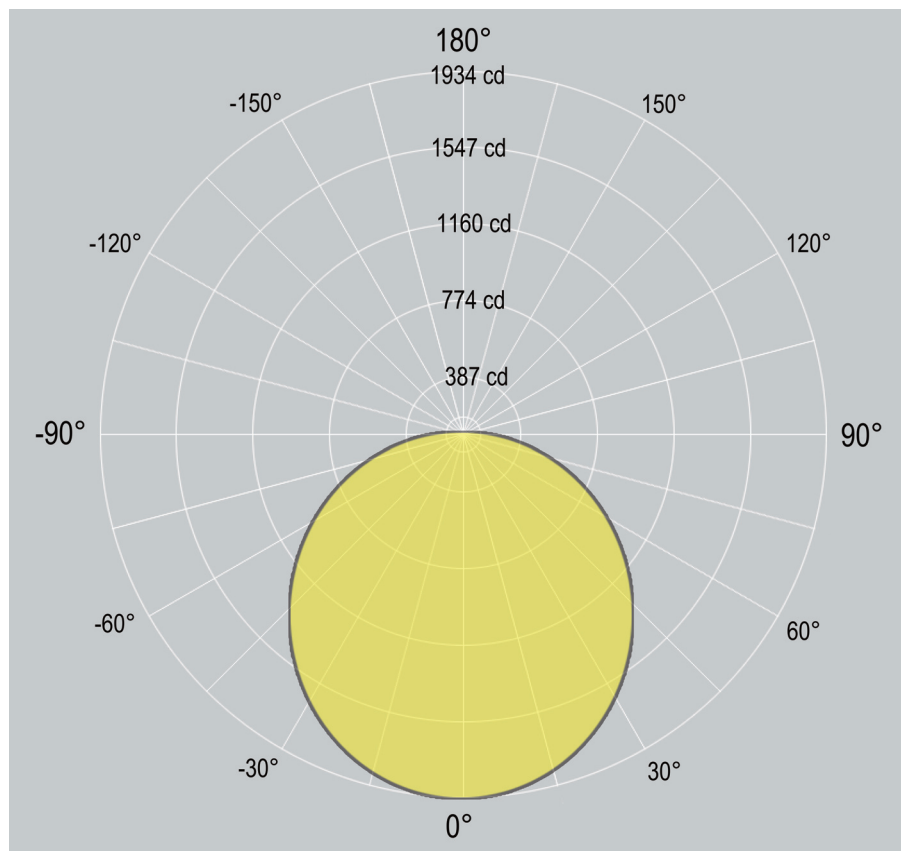

LIGHTPLANE 6 — LPL6

Suspended, Wall, Surface



1. Base Model

LPL6-S	Suspended
LPL6-WM	Wall Mounted
LPL6-SM	Surface Mounted

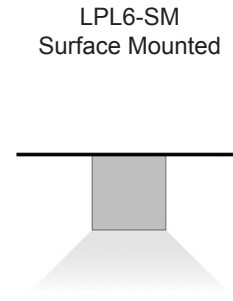
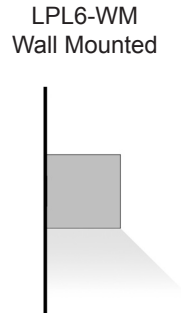
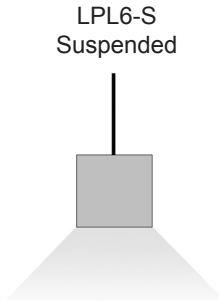

2. Run Length

Enter total linear length, (example: 6M)

3. Lamping

STD - xxxxK	Dual Row Linear LED Standard Output, LED 2X20W/M 5400 delivered lm/M, 95 lm/W @ 4000K
HI - xxxxK	High Output, LED 2X30W/M 6650 delivered lm/M, 90 lm/W @ 4000K
	CCT: 3000K 3500K 4000K Option: 2700K 5000K 5700K 6500K
CV	Additional Single Row LED Options Constant Voltage (for custom lengths) - 12Vdc/24Vdc Contact factory for detail
TW	Tunable White (2700K - 6500K) Contact factory for detail
RGBW	Standard Output - RGB+WHITE - 24Vdc/12Vdc Contact factory for detail

4. Spots (optional)

XX-7W	specify total quantity - 7W - 25/40 degree beam 135lm/W
XX-13W	specify total quantity - 13W - 25/40 degree beam 135lm/W
	CCT: 3000K 3500K 4000K
NOSPOTS	no spots



LIGHTPLANE 6 — LPL6

Suspended, Wall, Surface

ZALITE

5. Driver

0/1-10V	0/1-10V dimming
DALI	DALI dimming
DMX	DMX dimming
NONDIM	Non-dimmable
OTHER	(Consult factory for options)

6. Finish

AL	Standard, natural aluminum
BK	Black powdercoat
WH	White powdercoat
Custom	Custom Color

7. Additional options

EM	1.5 hour Emergency Kit
MS	Motion sensor
Others	Contact factory

LIGHTPLANE 6 — LPL6

Suspended, Wall, Surface

ZALITE

Housing

100% recyclable, extruded architectural grade T6063 aluminum

Emergency

Luminaires can be wired for emergency circuit and/or emergency battery backup.
Consult factory for options.

Options

Mitered Corners

Consult factory for mitered corner angle options.

Finish

Standard finish is "Ultimate" aluminum - a smooth, clean and durable finish achieved from a deep-etch and two step clear anodizing process.

White, Black, Custom powdercoat options also available.



Suspension & Power

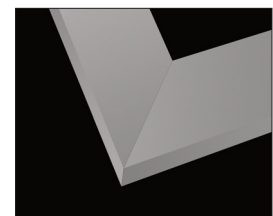

Mitered Corners

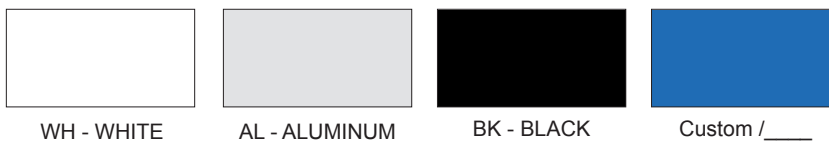

Default canopy finish
is to match fitting color,
unless otherwise
specified



ISO 9001:2015