

CE CB IP20 IK08 RoHS

Features

- Custom curved or straight shapes and configurations
- Remote driver, dim or non-dim available
- Wide range of finishes
- 100% recyclable, extruded architectural grade T6063 aluminum

Mounting

- Recessed

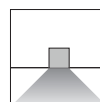

PHOTOS

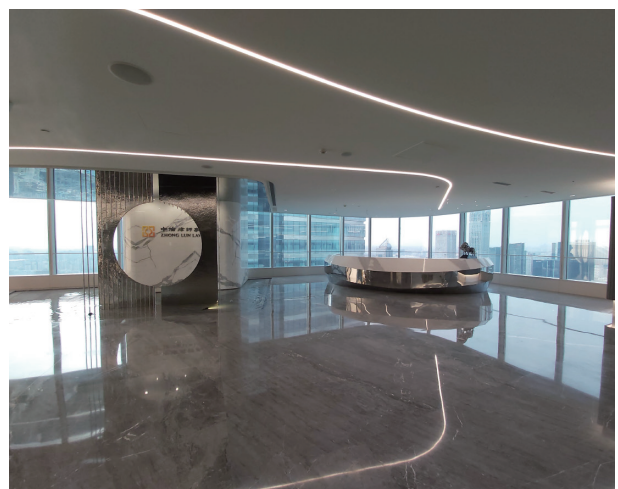

Dimensions

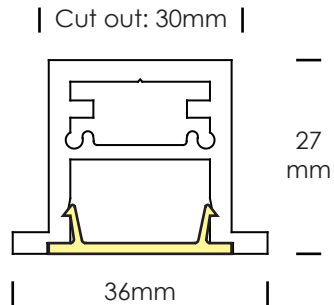

LPLR1M
Recessed

Distributions

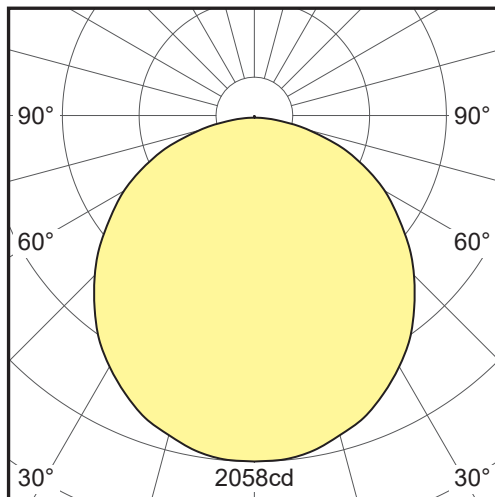

Ordering Info

1. BASIC MODEL

LPLR1M

Recessed

2. SIZE AND SHAPE

| | |
|-------------------------------|--|
| xxxxmm - CIRCLE | Circle - specify outside diameter in mm |
| xxxxmm - HCIRCLE | Half circle - specify outside diameter in mm |
| xxxxmm - 1/4 ARC | Quarter arc - specify outside diameter in mm |
| xxxxmm - STR | Straight - specify length in mm |
| xxxxmm - Special Shape | Radom connection of sectional circle, arc and straight |

* Sample configuration diagrams as below.

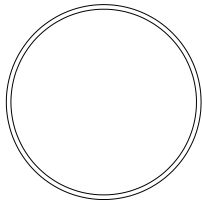

Circle

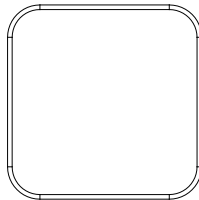

Rounded Rectangle

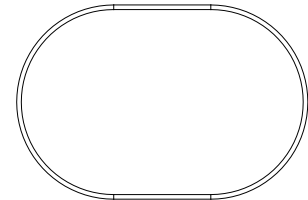

Stadium Oval

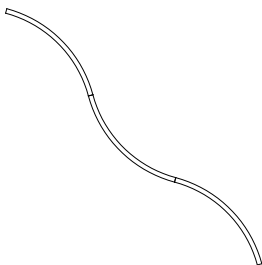

Serpentine

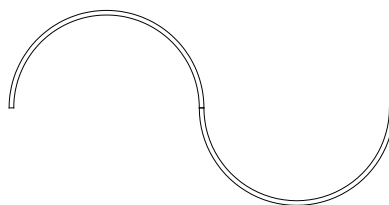

S-Shape

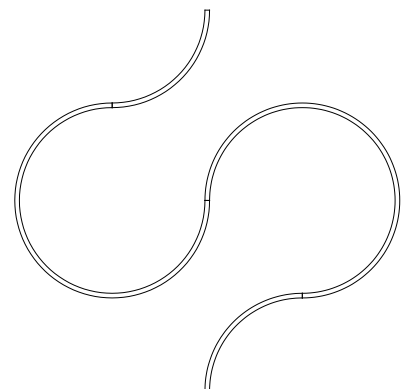

Curve

3. LED LAMPING

| | |
|--------------------|--|
| LOW - xxxxK | Linear LED strip, low output, LED 10W/M |
| STD - xxxxK | Linear LED strip, standard output, LED 20W/M |
| HI - xxxxK | Linear LED strip, high output, LED 30W/M |

Note: Standard CCT: **3000K, 3500K, 4000K**; **CRI80 and CRI90** are available.

Other option: 2700K, 5000K, 5700K, 6500K, red, green, blue, RGB, TUNE(2700K-6500K). Contact factory for details.

See page 6 for information of LED lamping output.

4. DRIVER

| | |
|----------------|-----------------------------|
| STD | Non-dimmable |
| 0/1-10V | 1-10V / 0-10V dimming |
| DALI | DALI dimming |
| DMX | DMX dimming |
| OTHER | Consult factory for options |

5. FINISH

| | |
|-----------|--|
| BK | Matt black powercoat |
| WH | Matt white powercoat |
| SG | Silver grey powercoat |
| CF | Custom finish - RAL or Pantone or other finish options |



Matt black

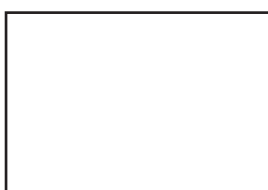

Matt white



Silver grey



Custom

6. OPTIONAL ADD-ONS

| | |
|---------------|--------------------------------------|
| EM | 1.5 hour emergency kit (remote only) |
| SS | PIR sensor |
| OTHERS | Consult factory for options |

SPECIFICATION DETAILS

PERFORMANCE DATA - LED LAMPING

| OUTPUT OPTIONS | DELIVERED LUMENS | WATTS | CRI OPTIONS | CCT OPTIONS | LED LAMPING |
|----------------|------------------|-------|-------------|--|--|
| D900-LOW | 2212 | 32 | 80 90 | 2700K 3000K 3500K 4000K 5000K 6500K | 900mm in diameter, 10 watts per meter |
| D900-STD | 4424 | 64 | | | 900mm in diameter, 20 watts per meter |
| D1200-LOW | 3387 | 49 | | | 1200mm in diameter, 10 watts per meter |
| D1200-STD | 6774 | 98 | | | 1200mm in diameter, 20 watts per meter |
| D1500-LOW | 3732 | 54 | | | 1500mm in diameter, 10 watts per meter |
| D1500-STD | 7465 | 108 | | | 1500mm in diameter, 20 watts per meter |

Note: Data provided is from a photometric test of ϕ 1.2 meter fixture output with 90CRI at 4000K using a non-dimmable driver.



More information and data,
please visit:
www.zalite.cn

V1.0_2024-10