

---

# LIGHTPLANE 1 WALL WASHER

## LPLR1WWT

Recessed

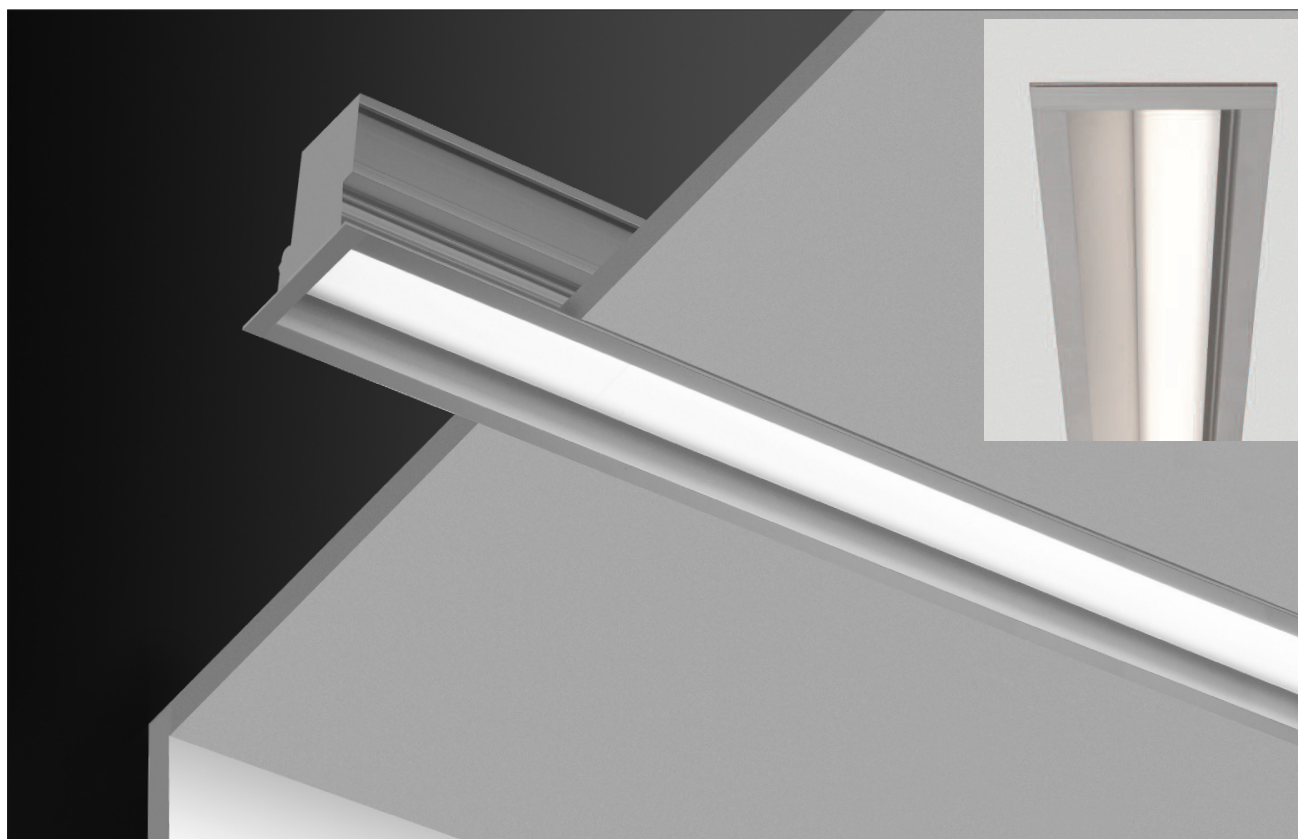

# LIGHTPLANE 1 WALL WASHER LPLR1WWT

# ZALITE

Recessed

## Dimensions

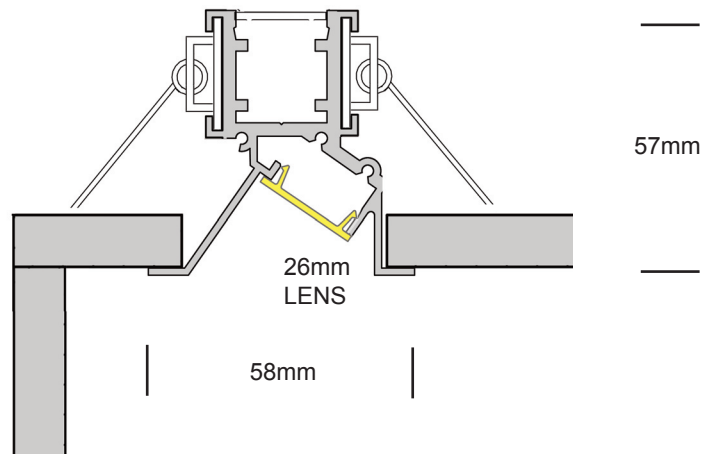

## Distribution

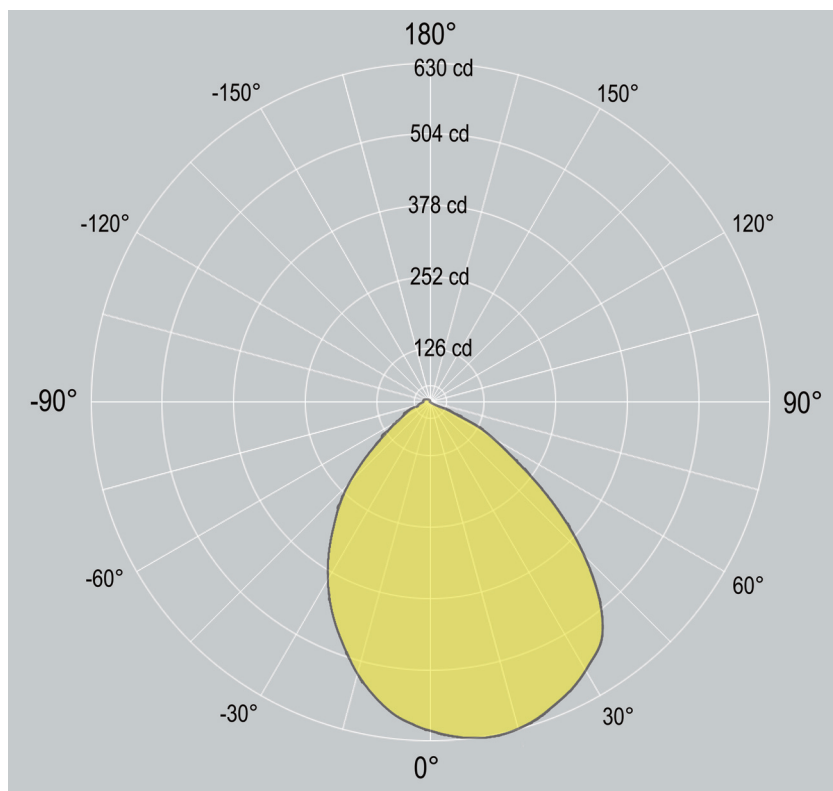

# LIGHTPLANE 1 WALL WASHER

## LPLR1WWT

# ZALITE

Recessed

### 1. Base Model

LPLR1WWT

Recessed Wall Washer - (with Trim)

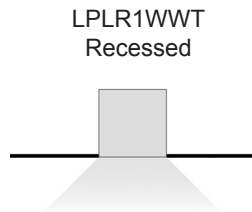

### 2. Run Length

Enter total linear length, (example: 6M)

### 3. LED Lamping

STD - **xxxxK** (example: STD-4000K)

Standard Output, LED 20 W/M, 1450 delivered lm/M , 62 lm/W @ 4000K

HI - **xxxxK** (example: HI-4000K)

High Output, LED 30 W/M, 2065 delivered lm/M, 59 lm/W @ 4000K

CCT: 3000K 3500K 4000K Option: 2700K 5000K 5700K 6500K

CV - **xxxxK**

Additional LED Options

Constant Voltage (for custom lengths) - 12Vdc/24Vdc

Contact factory for detail

TW

Tunable White (2700K - 6500K)

Contact factory for detail

RGBW - **xxxxK**

Standard Output - RGB+WHITE - 12Vdc/24Vdc

Contact factory for detail

### 4. LED Driver (remote only)

0/1-10V

0/1-10V dimming

DALI

DALI dimming

DMX

DMX dimming

NONDIM

Non-dimmable

OTHER

(Consult factory for options)

### 5. Finish

AL

Standard, natural aluminum

BK

Black powdercoat

WH

White powdercoat

Custom

Custom Color

### 6. Additional options (remote only)

EM

1.5 Hour Emergency Kit - remote

MS

Motion sensor

Others

Contact factory

# LIGHTPLANE 1 WALL WASHER

## LPLR1WWT

# ZALITE

Recessed

---

### Housing

100% recyclable, extruded architectural grade T6063 aluminum

---

### Emergency

Luminaires can be wired for emergency circuit and/or emergency battery backup.  
Consult factory for options.

---

### Options

#### Mitered Corners

Consult factory for mitered corner angle options.

---

### Finish

Standard finish is "Ultimate" aluminum - a smooth, clean and durable finish achieved from a deep-etch and two step clear anodizing process.

White, Black, Custom powdercoat options also available.

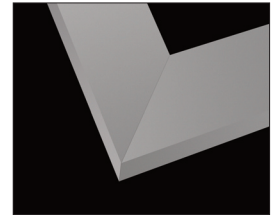

Mitered Corners



WH - WHITE

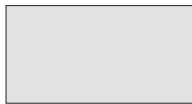

AL - ALUMINUM



BK - BLACK

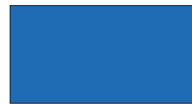

Custom/\_\_\_\_



ISO 9001:2015