

LIGHTPLANE RECESSED 6

LPLR6 & LPLR6T

Recessed

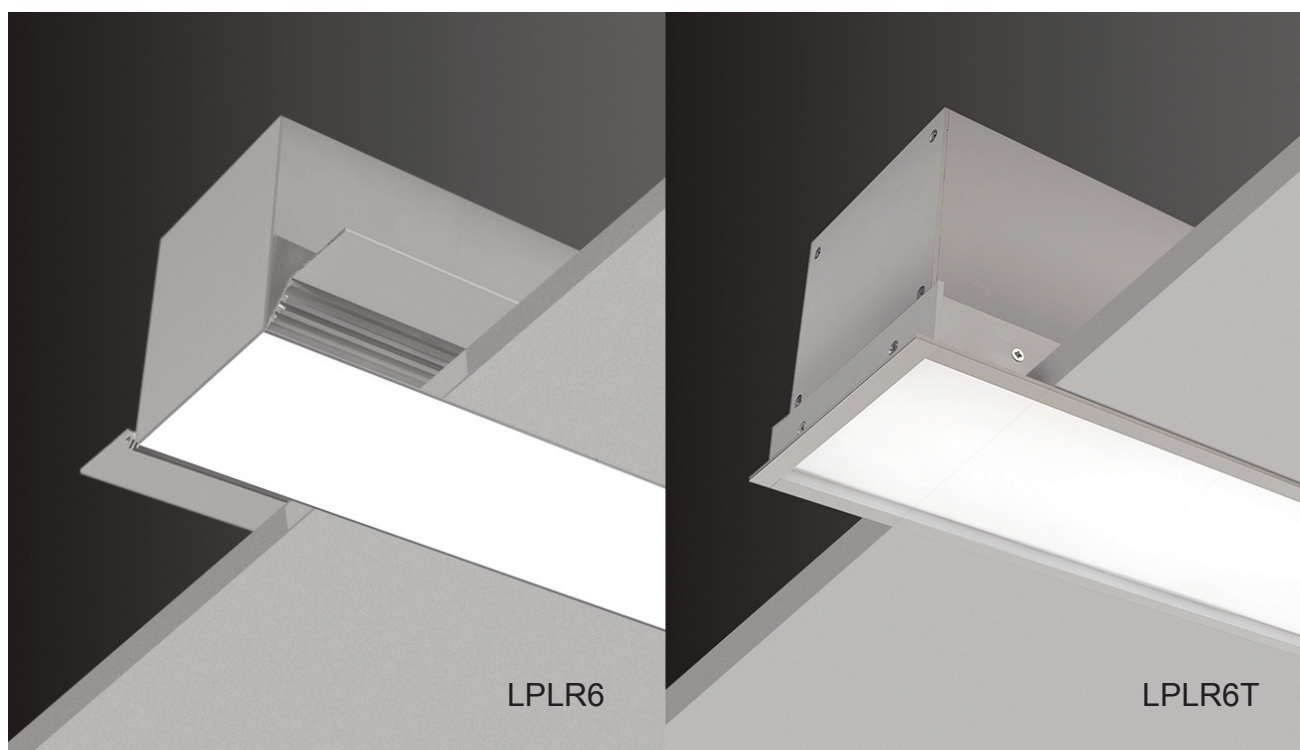

LIGHTPLANE RECESSED - LPLR6 & LPLR6T



Recessed

Dimensions

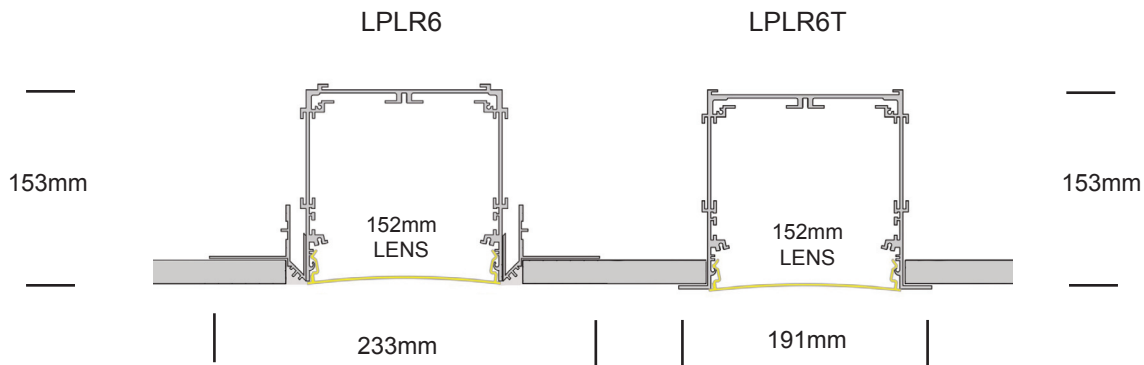

Distribution

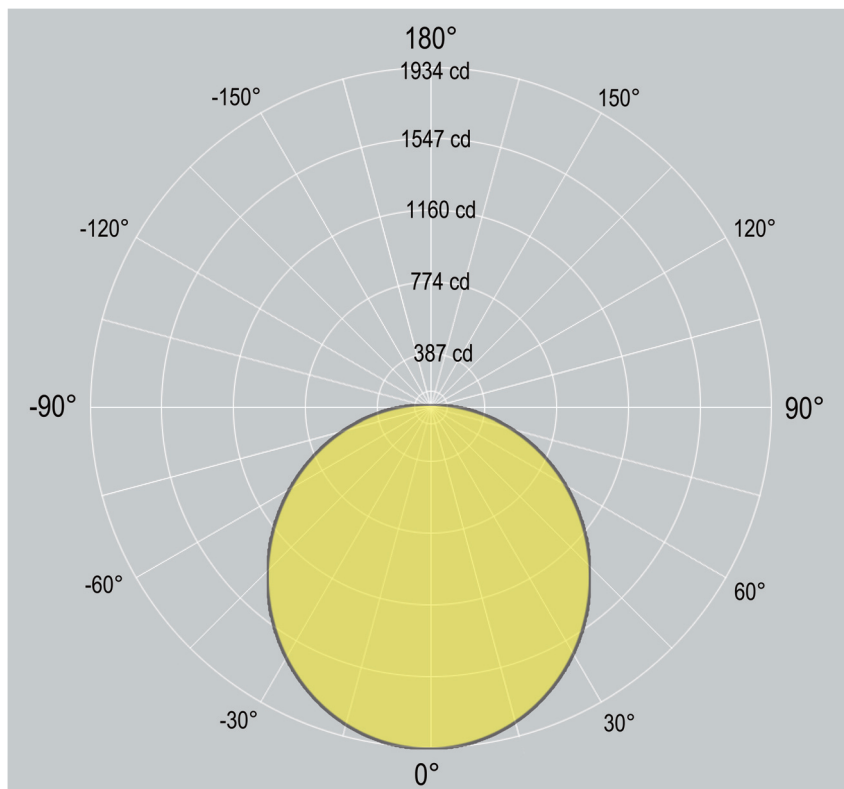

LIGHTPLANE RECESSED - LPLR6 & LPLR6T



Recessed

1. Base Model

LPLR6	Recessed - Trimless
LPLR6T	Recessed - with Trim

LPLR6 & LPLR6T
Recessed

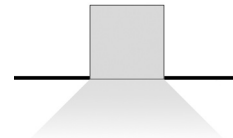

2. Run Length

Enter total linear length, (example: 6M)

3. Lamping

	Dual Row Linear LED
STD - xxxxK	Standard Output, LED 2X20W/M 5400 delivered lm/M, 95 lm/W @ 4000K
HI - xxxxK	High Output, LED 2X30W/M 6650 delivered lm/M, 90 lm/W @ 4000K

CCT: 3000K 3500K 4000K Option: 2700K 5000K 5700K 6500K

	Additional Single Row LED Options
CV	Constant Voltage (for custom lengths) - 12Vdc/24Vdc Contact factory for detail
TW	Tunable White (2700K - 6500K) Contact factory for detail
RGBW	Standard Output - RGB+WHITE - 24Vdc/12Vdc Contact factory for detail

4. Spots (optional)

XX-7W	specify total quantity - 7W - 25/40 degree beam 135lm/W
XX-13W	specify total quantity - 13W - 25/40 degree beam 135lm/W
NOSPOTS	CCT: 3000K 3500K 4000K no spots

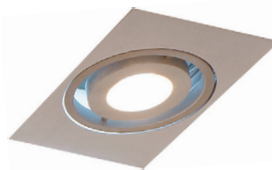

5. Driver

0/1-10V	0/1-10V dimming
DALI	DALI dimming
DMX	DMX dimming
NONDIM	Non-dimmable
OTHER	(Consult factory for options)

6. Finish

AL	Standard, natural aluminum
BK	Black powdercoat
WH	White powdercoat
Custom	Custom Color

7. Additional options

EM	1.5 hour Emergency Kit
MS	Motion sensor
Others	Contact factory

LIGHTPLANE RECESSED - LPLR6 & LPLR6T

ZALITE

Recessed

Housing

100% recyclable, extruded architectural grade T6063 aluminum

Emergency

Luminaires can be wired for emergency circuit and/or emergency battery backup.
Consult factory for options.

Options

Mitered Corners

Consult factory for mitered corner angle options.

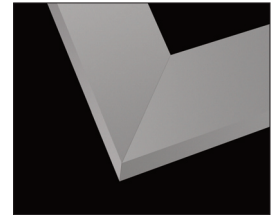

Mitered Corners

Finish

Standard finish is "Ultimate" aluminum - a smooth, clean and durable finish achieved from a deep-etch and two step clear anodizing process.

White, Black, Custom powdercoat options also available.



WH - WHITE

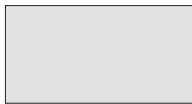

AL - ALUMINUM



BK - BLACK

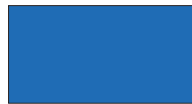

Custom/____



ISO 9001:2015