

CE IP20 IK08 RoHS

Features

- Asymmetric optic design
- High performance dimmable LED light source
- Wide range of finishes, acoustic felt and sticker
- 100% recyclable, extruded architectural grade T6063 aluminum

Mounting

- Suspended, surface

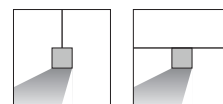

Dimensions

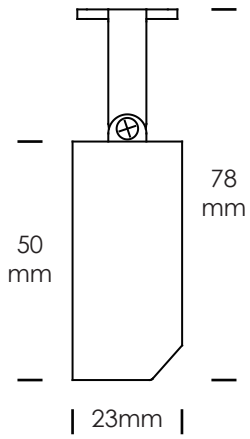

Distributions

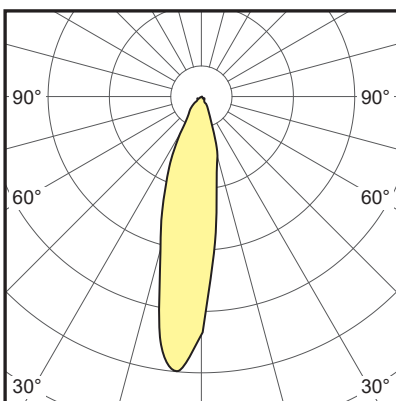

Ordering Info

1. BASIC MODEL

LLF1-S	Suspended
LLF1-SM	Surface mount

2. SIZE AND SHAPE

xxxxmm - STR	Straight - specify individual or continuous run length in mm
xxxxmm - SQ	Square - specify outside dimension in mm
xxxxmm - REC	Rectangle - specify outside dimension in mm
xxxxmm - TEE	T- Shape - specify length in mm
xxxxmm - Special Shape	Radom connection of sectional straight

* Sample configuration diagrams as below.



Square



Rectangle



U-Shape



T-Shape



Cross



Zed

3. LED LAMPING

LOW - xxxxK	Optic module, low output, LED 12W/M
MED - xxxxK	Optic module, medium output, LED 17.5W/M
STD - xxxxK	Optic module, standard output, LED 24W/M
HI - xxxxK	Optic module, high output, LED 32W/M

Note: Standard CCT: **3000K, 3500K, 4000K**; **CRI80 and CRI90** are available.
 Other option: 2700K, 5000K, 5700K, 6500K, red, green, blue. Contact factory for details.
 See page 7 for information of LED lamping output.

4. DRIVER

STD	Non-dimmable
0/1-10V	1-10V / 0-10V dimming
DALI	DALI dimming
DMX	DMX dimming
OTHER	Consult factory for options

5. SUSPENSION MOUNT CANOPY

RC	Canopy in round shape - suspended only
SC	Canopy in square shape - suspended only
PS	Powered suspension kits, no canopy- suspended only

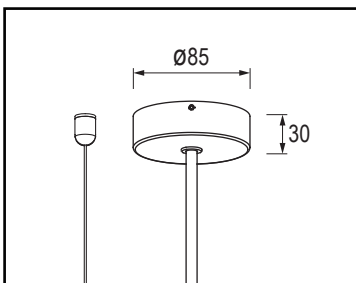

Round canopy

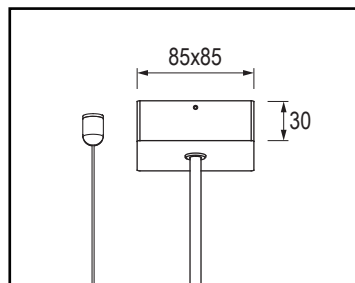

Square canopy

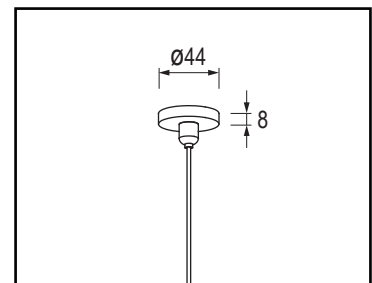

Powered suspension kit

Linear Light Fall 1 Inch

ZALITE

Suspended, Surface

6. FINISH

BK	Matt black powercoat
WH	Matt white powercoat
SG	Silver grey powercoat
CF	Custom finish - RAL or Pantone or other finish options



Matt black



Matt white



Silver grey

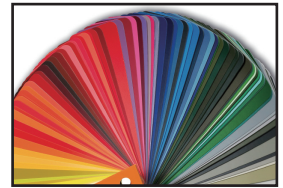

Custom

7. OPTIONAL ADD-ONS

EM	1.5 hour emergency kit (remote only)
SS	PIR sensor
OTHERS	Consult factory for options

SPECIFICATION DETAILS

ADJUSTABLE MOUNTING BRACKET

The fixture is designed with adjustable mounting bracket for surface mount. The bracket is 180 degrees adjustable, providing flexible and convenient installation in field. You can easily adjust the light's angle to get perfect wall-washing.

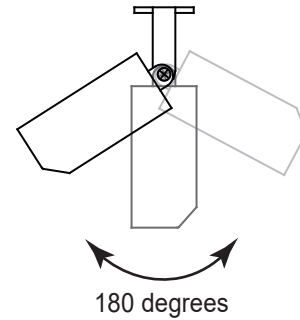

WALL WASHER

The wall washer is a flexible module design with wall wash optic and SMD LED strip. The precision optic's engineered for clean-cut light spot edges, ensuring precise and uniform wall illumination. Uniform light distribution provides a more consistent and even washing effect across vertical surfaces, enhancing visual comfort and ambiance.

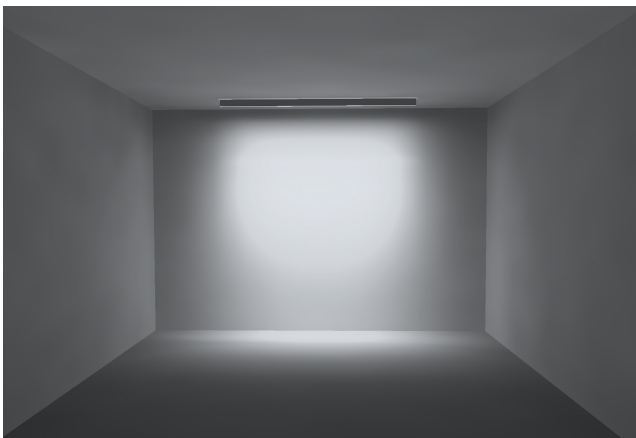

LLF1

75W, 4000K, direct light only

Length: 2.88 meters

Washing dimension: 3 x 2.4m

Room Values

Room dimensions 5.4 x 3.6 x 3.6m

Reflection factor 0.7 | 0.5 | 0.2

Maintenance factor 0.8

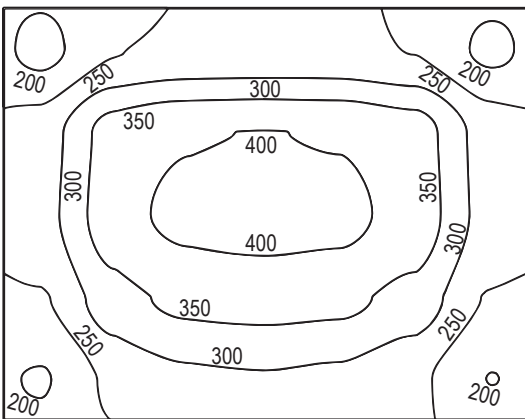

Area dimensions 3.0 x 2.4m

\bar{E} 307lx

E_{MIN} 186lx

E_{MAX} 417lx

$U_0(g_1)$ 0.61

g_2 0.45

Height 2.200m

Linear Light Fall 1 Inch

Suspended, Surface

ZALITE

PERFORMANCE DATA - LED LAMPING

OUTPUT OPTIONS	DELIVERED LUMENS	WATTS	CCT OPTIONS	LED LAMPING
LOW-3000K	1182	11.6	2700K 3000K 3500K 4000K 5000K 6500K	LED strip
LOW-4000K	1252	11.6		
MED-3000K	1679	17		
MED-4000K	1779	17		
STD-3000K	2249	23.2		
STD-4000K	2383	23.2		
HI-3000K	2829	30.5		
HI-4000K	2997	30.5		

Note: Data provided for LED strip options is from a photometric test of 0.96 meter fixture output with 90CRI at 4000K using a non-dimmable driver.



More information and data,
please visit:
www.zalite.cn

V1.0_2025-05