



MR2SS-S-650-CIRCLE-SSTD-LSTD-LSTD-BK

Features

- Direct-indirect distribution
- Low UGR reflector design
- Rolled soft acrylic lens presents seamless continuous light
- Custom curved or straight shapes and configurations
- Dim or non-dim driver available
- Wide range of finishes
- 100% recyclable, extruded architectural grade T6063 aluminum

Mounting

- Suspended, surface, recessed

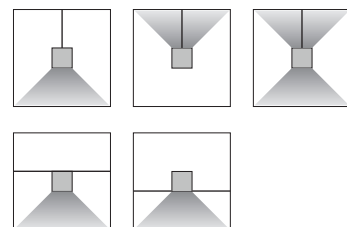

Moonring 2 Snake Spot - MR2SS

Suspended, Surface, Recessed

ZALITE

PHOTOS



Dimensions

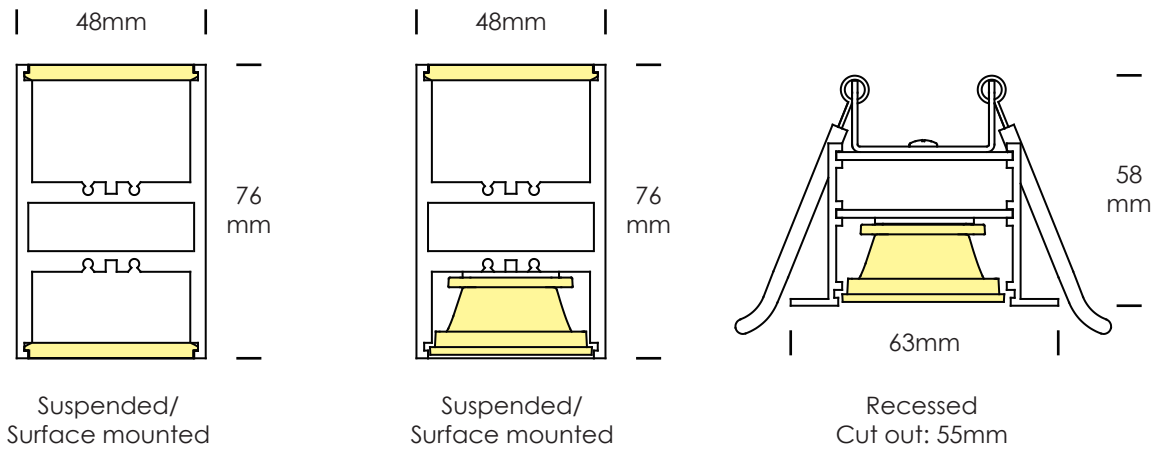

Distributions

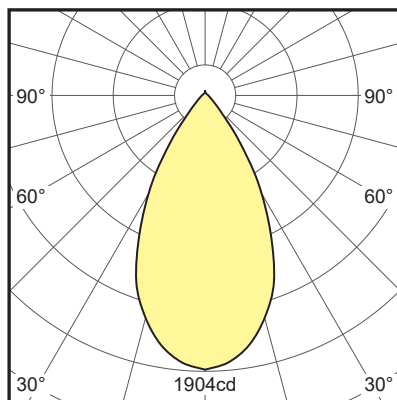

Spot cluster- direct

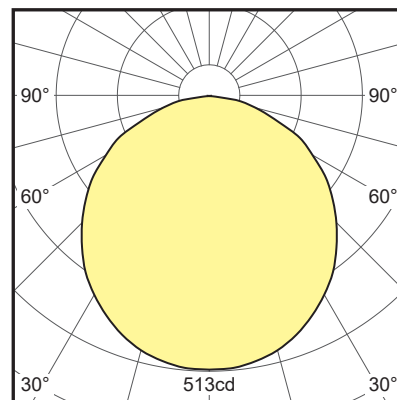

LED strip- direct

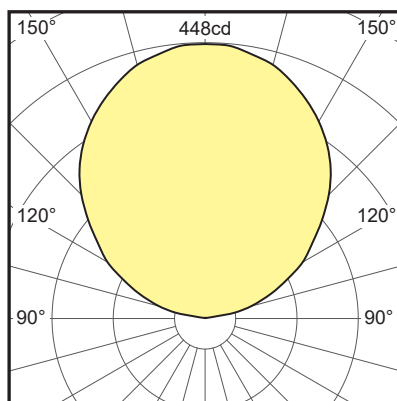

LED strip- indirect

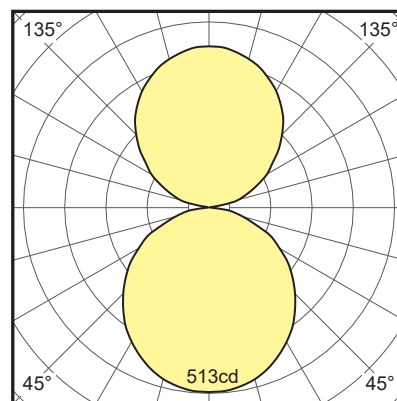

LED strip-direct and indirect

Ordering Info

1. BASIC MODEL

MR2SS-S	Suspended - direct / indirect / direct-indirect
MR2SS-SM	Surface mount - direct only
MR2SS-RT	Recessed with trim - direct only

2. SIZE AND SHAPE

xxxxmm - CIRCLE	Circle - specify outside diameter in mm
xxxxmm - HCIRCLE	Half circle - specify outside diameter in mm
xxxxmm - 1/4 ARC	Quarter arc - specify outside diameter in mm
xxxxmm - STR	Straight - specify length in mm
xxxxmm - Special Shape	Radom connection of sectional circle, arc and straight

* Sample configuration diagrams as below.

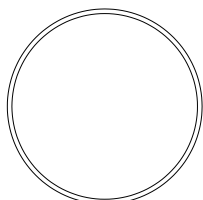

Circle

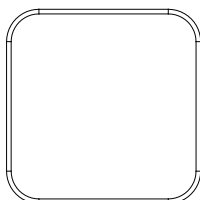

Rounded Rectangle

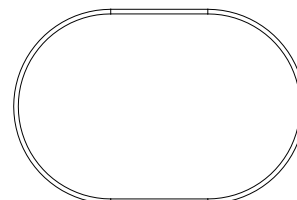

Stadium Oval

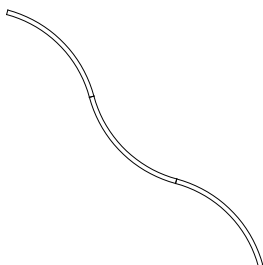

Serpentine

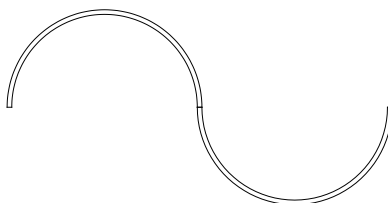

S-Shape

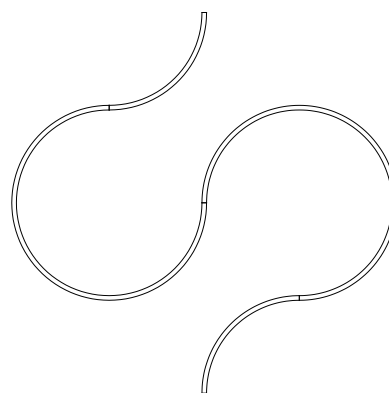

Curve

Moonring 2 Snake Spot - MR2SS

Suspended, Surface, Recessed

3. LED LAMPING - DIRECT LIGHT

L - STD - xxxxK	Linear LED strip, standard output, LED 20W/M
L - HI - xxxxK	Linear LED strip, high output, LED 30W/M
S - LOW - xxxxK	Spot cluster, low output, LED 5.4W per cluster
S - STD - xxxxK	Spot cluster, standard output, LED 7.2W per cluster
S - HI - xxxxK	Spot cluster, high output, LED 9W per cluster
NON	No Linear LED strip or spot cluster, with blank spacer plate

Note: Standard CCT: 3000K, 3500K, 4000K; CRI80 and CRI90 are available.

Other option: 2700K, 5000K, 5700K, 6500K, red, green, blue, TUNE(2700K-6500K). Contact factory for details.

See page 7 for more specification of spot cluster, see page 8 for information of LED lamping output.

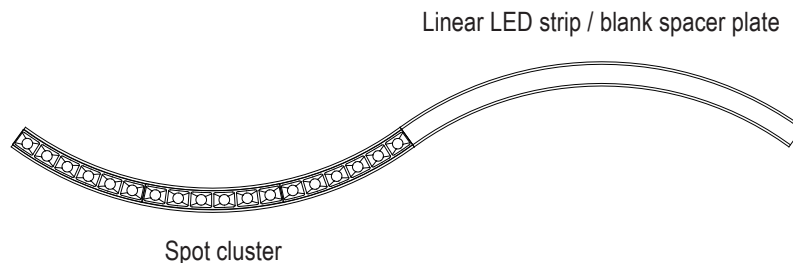

4. LED LAMPING - INDIRECT LIGHT

L - STD - xxxxK	Linear LED strip, standard output, LED 20W/M
L - HI - xxxxK	Linear LED strip, high output, LED 30W/M
S - LOW - xxxxK	Spot cluster, low output, LED 5.4W per cluster
S - STD - xxxxK	Spot cluster, standard output, LED 7.2W per cluster
S - HI - xxxxK	Spot cluster, high output, LED 9W per cluster
NON	DIRECT-ONLY fixture

Note: Standard CCT: 3000K, 3500K, 4000K; CRI80 and CRI90 are available.

Other option: 2700K, 5000K, 5700K, 6500K, red, green, blue, TUNE(2700K-6500K). Contact factory for details.

See page 7 for more specification of spot cluster, see page 8 for information of LED lamping output.

5. DRIVER (REMOTE ONLY)

STD	Non-dimmable
0/1-10V	1-10V / 0-10V dimming
DALI	DALI dimming
DMX	DMX dimming
OTHER	Consult factory for options

Moonring 2 Snake Spot - MR2SS

ZALITE

Suspended, Surface, Recessed

6. SUSPENSION MOUNT CANOPY

RC	Canopy in round shape - suspended only
SC	Canopy in square shape - suspended only
PS	Powered suspension kits, no canopy- suspended only

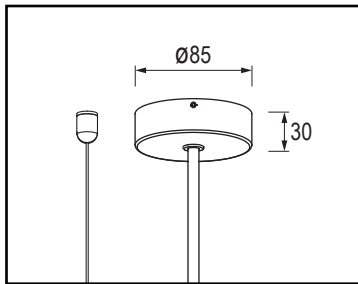

Round canopy

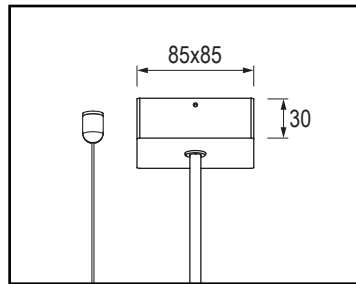

Square canopy

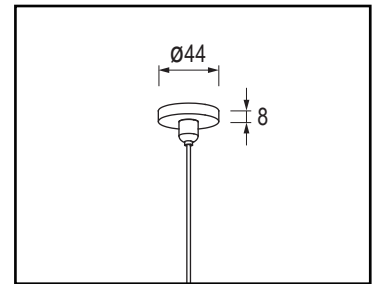

Powered suspension kit

7. FINISH

BK	Matt black powercoat
WH	Matt white powercoat
SG	Silver grey powercoat
CF	Custom finish - RAL or Pantone or other finish options



Matt black



Matt white



Silver grey

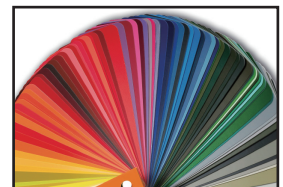

Custom

8. OPTIONAL ADD-ONS

EM	1.5 hour emergency kit (remote only)
SS	PIR sensor
OTHERS	Consult factory for options

SPECIFICATION DETAILS

SPOT CLUSTER

Spot Cluster is a series of straight and arc module with 6-head reflectors and Osram LEDs. Reflector is designed with 50 degree distribution and UGR<15. The series includes a 250mm straight and 2 different outside diameters - ϕ 650mm, ϕ 1300mm, provides more configuration designs.

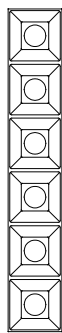

Straight

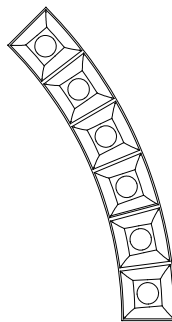

ϕ 650mm -
45 deg arc

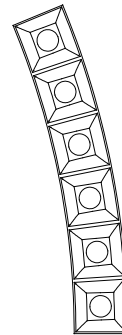

ϕ 1300mm -
22.5 deg arc

ROLLED LENS

The optically engineered rolled soft acrylic lens provides smooth, uniform and seamless illumination for linear lengths of 30 meters while dynamically controlling output and reducing glare. The soft acrylic lens rolls out and snaps into the housing profile for easy installation.

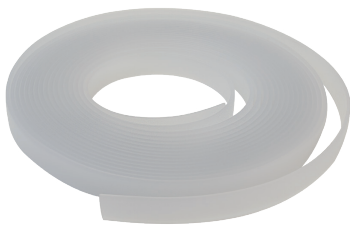

Rolled soft acrylic lens



Moonring 2 Snake Spot - MR2SS

ZALITE

Suspended, Surface, Recessed

PERFORMANCE DATA - LED LAMPING

OUTPUT OPTIONS	DELIVERED LUMENS	WATTS	CRI OPTIONS	CCT OPTIONS	LED LAMPING
L-STD	2708	48	80 90	2700K 3000K 3500K 4000K 5000K 6500K	LED strip, direct-indirect light
L-HI	3803	73.5			LED strip, direct-indirect light
L-STD-D	1466	24			LED strip, direct light only
L-HI-D	2062	36.8			LED strip, direct light only
S-LOW	562	6			One spot cluster
S-STD	738	8.1			One spot cluster
S-HI	915	10.7			One spot cluster

*Note: Data provided for LED strip options is from a photometric test of 1 meter fixture output with 90CRI at 4000K using a non-dimmable driver.
Data provided for spot cluster options is from a photometric test of one set of spot cluster output with 90CRI at 4000K using a non-dimmable driver.*



*More information and data,
please visit:
www.zalite.cn*

V3.0_2022-08