

PLANE

PLNI - Indirect Suspended Ceiling Washer

PLNIDI - Indirect Suspended Ceiling Washer with Direct

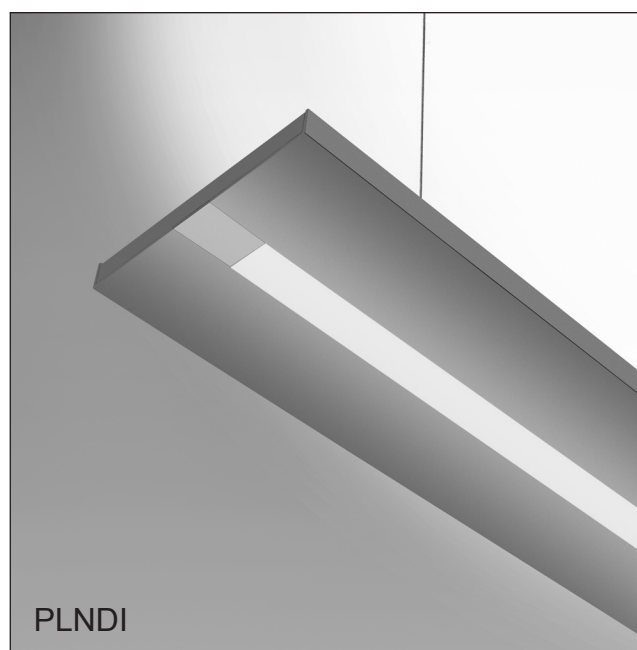
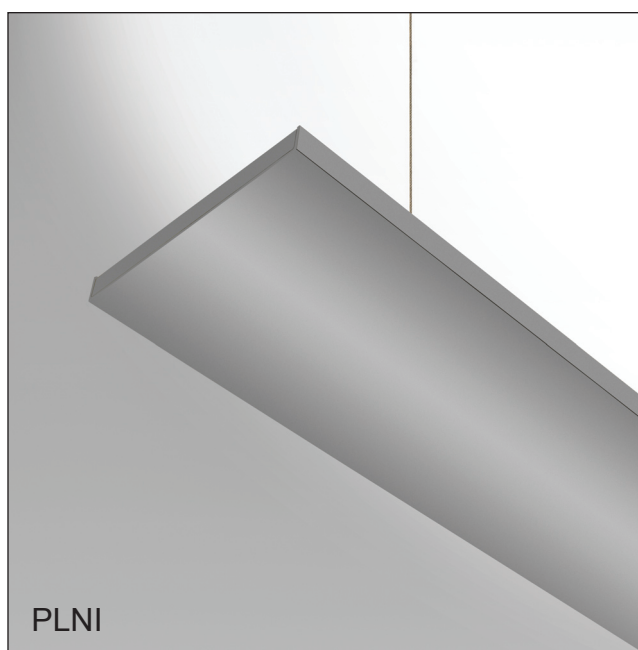

PLNI & PLNDI

Indirect Suspended Ceiling Washer

ZALITE

Dimensions

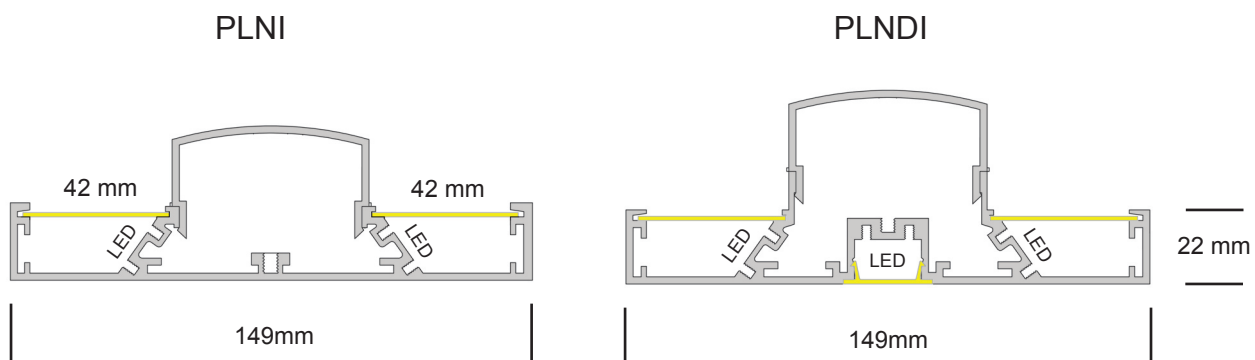

Distribution

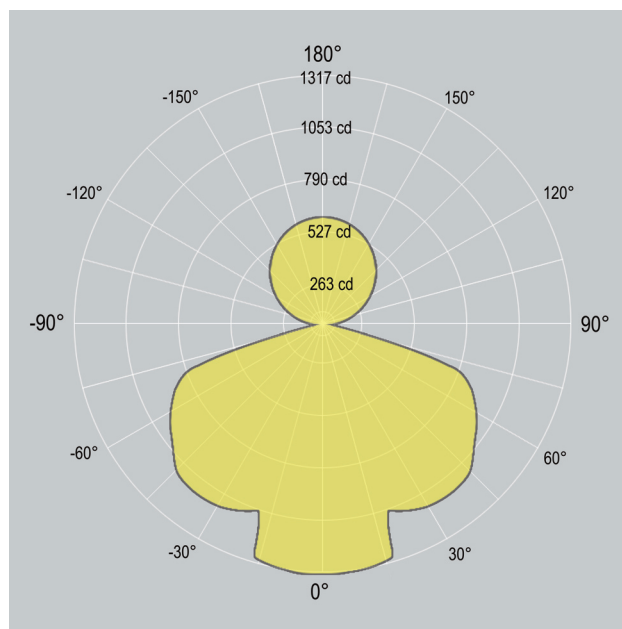
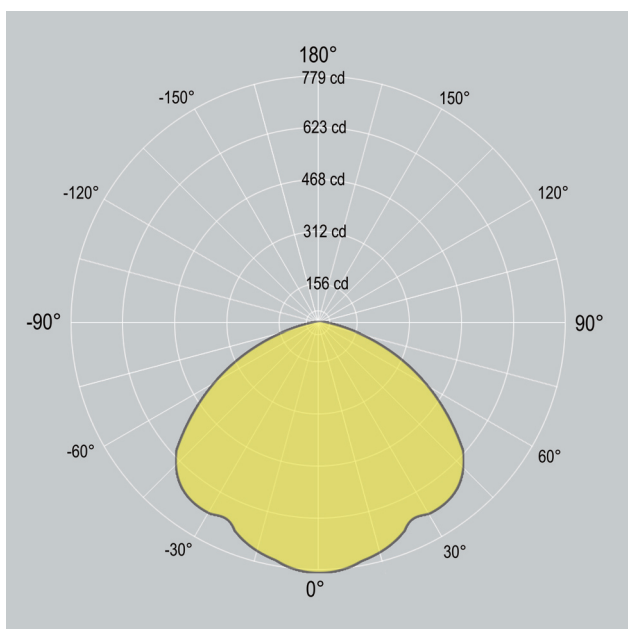

PLNI & PLNDI

Indirect Suspended Ceiling Washer

ZALITE

1. Base Model

PLNI	Indirect Suspended Ceiling Washer
PLNDI	Indirect Suspended Ceiling Washer with Direct

PLNI & PLNDI
Suspended

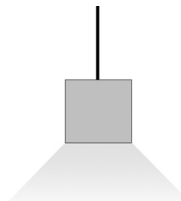

2. Run Length

Enter total linear length, (example: 6M)

3. Lamping (uplight)

	PLNI Dual Row Linear LED Indirect Only
STD - xxxxK	Standard Output, LED 2X20W/M 2200 delivered lm/M, 92 lm/W @ 4000K
HI - xxxxK	High Output, LED 2X30W/M 6000 delivered lm/M, 87 lm/W @ 4000K

	PLNDI Dual Row Linear LED Indirect/Single LED Direct
STD - xxxxK	Standard Output, LED 3X20W/M 5700 delivered lm/M, 88 lm/W @ 4000K
HI - xxxxK	High Output, LED 3X30W/M 8800 delivered lm/M, 84 lm/W @ 4000K

CCT: 3000K 3500K 4000K Option: 2700K 5000K 5700K 6500K

	Additional Single Row LED Options
CV	Constant Voltage (for custom lengths) - 12Vdc/24Vdc Contact factory for detail
TW	Tunable White (2700K - 6500K) Contact factory for detail
RGBW	Standard Output - RGB+WHITE - 24Vdc/12Vdc Contact factory for detail

4. Driver

0/1-10V	0/1-10V dimming
DALI	DALI dimming
DMX	DMX dimming
NONDIM	Non-dimmable
OTHER	(Consult factory for options)

5. Finish

AL	Standard, natural aluminum
BK	Black powdercoat
WH	White powdercoat
Custom	Custom Color

6. Additional options

EM	1.5 hour Emergency Kit
MS	Motion sensor
Others	Contact factory

PLNI & PLNDI

Indirect Suspended Ceiling Washer

ZALITE

Housing

100% recyclable, extruded architectural grade T6063 aluminum

Emergency

Luminaires can be wired for emergency circuit and/or emergency battery backup.
Consult factory for options.

Options

Mitered Corners

Consult factory for mitered corner angle options.

Finish

Standard finish is "Ultimate" aluminum - a smooth, clean and durable finish achieved from a deep-etch and two step clear anodizing process.
White, Black, Custom powdercoat options also available.



Suspension & Power

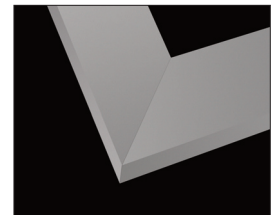

Mitered Corners



WH - WHITE

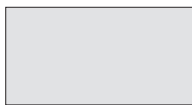

AL - ALUMINUM



BK - BLACK



Custom / ____

Default canopy finish
is to match fitting color,
unless otherwise
specified



ISO 9001:2015