

---

# LPLRTGRID

Suspended Ceiling System

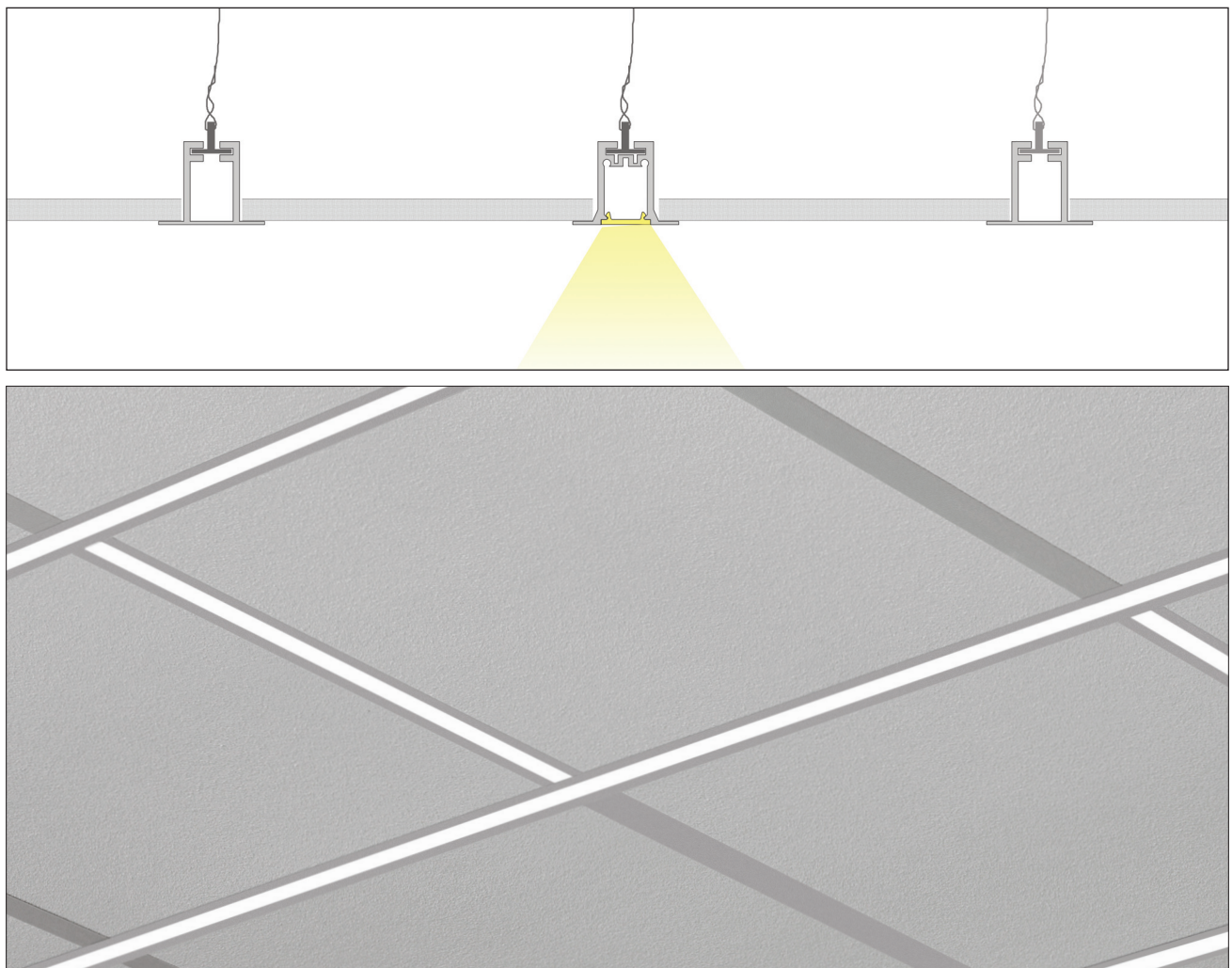

Dimensions

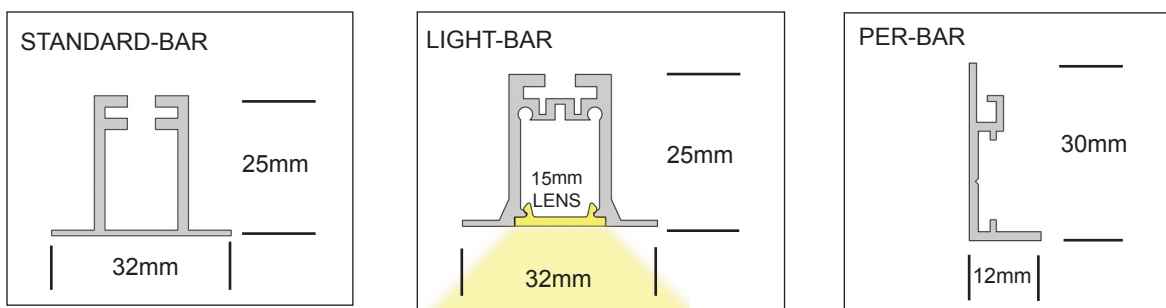

Distribution

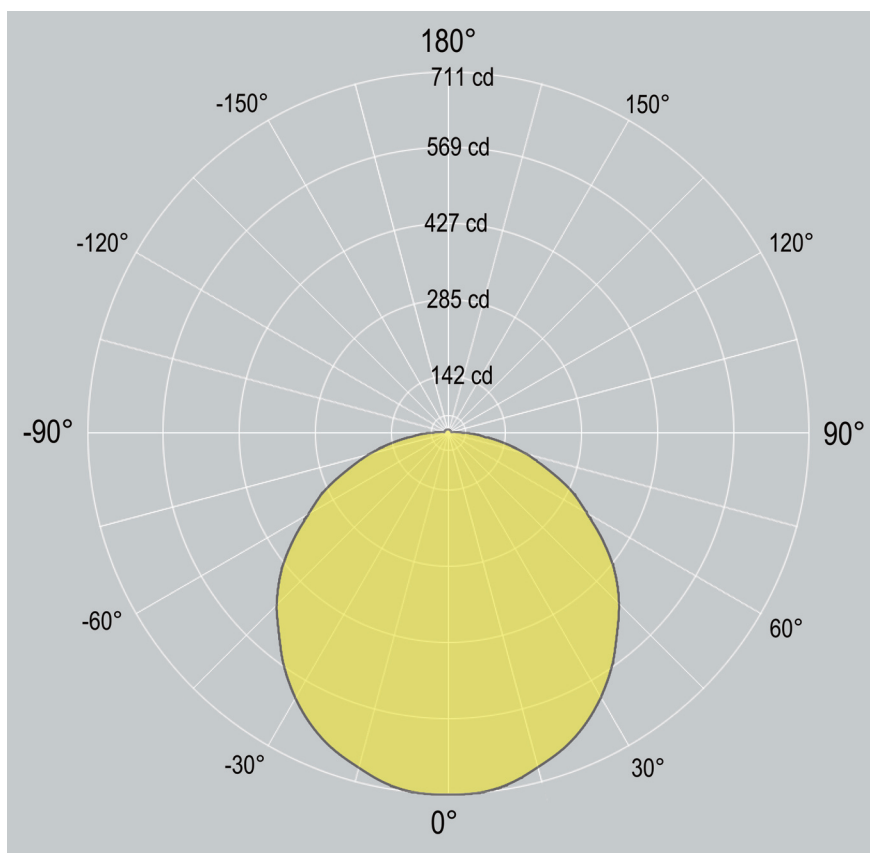

# LPLRTGRID

Suspended Ceiling System

# ZALITE

## LPLRTGRID - Suspended Ceiling System

LPLRTGRID is a complete drop down suspension system for hanging acoustic ceiling panels. Linear LED light can be incorporated into the actual T-BAR supports. The frame can be cut to support any size ceiling panels. Any combination of illuminated or no-illuminated T-BAR can be mixed and constructed.

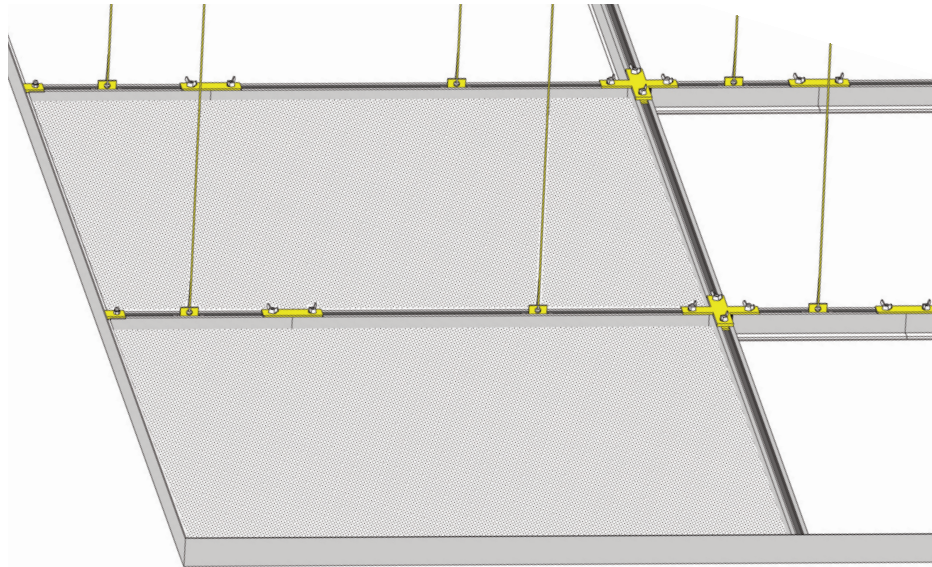

To specify LPLRTGRID, order from the following part list.

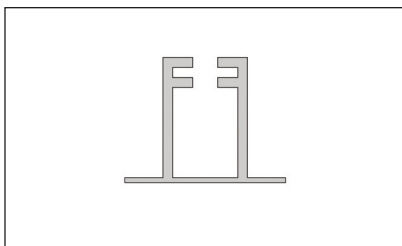

**STANDARD-BAR**  
Extruded Aluminum support bar  
No LED incorporated

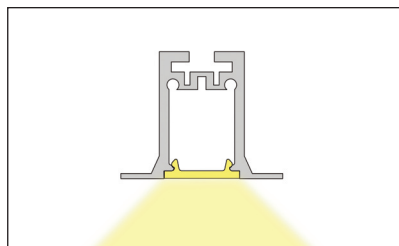

**LIGHT-BAR**  
Extruded Aluminum support bar  
With LED Incorporated.

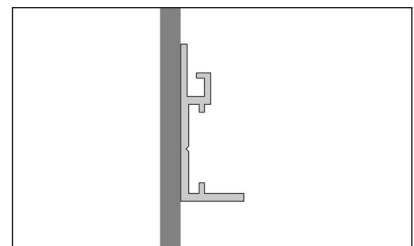

**PER-BAR**  
Extruded Aluminum support bar  
For perimeter. Affixed to wall or floats.

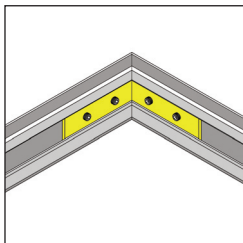

**TGRID-90D**  
90 degree connector  
for PER-BAR

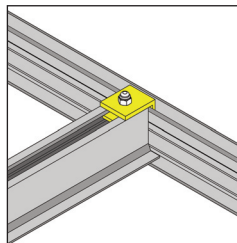

**TGRID-CLIP**  
Connector clip to  
connect either STANDARD-  
BAR or LIGHT-BAR to the  
PER-BAR

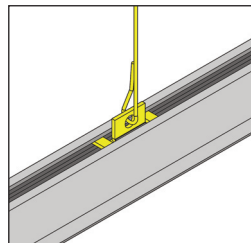

**TGRID-HANGER**  
Hanger Clip to suspend  
either STANDARD-BAR  
or LIGHT-BAR.

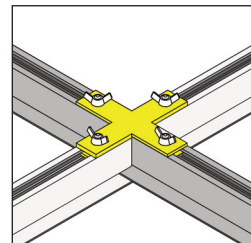

**TGRID-CROSS**  
Cross connector. Secures  
any bars together where  
they cross.

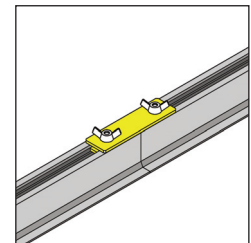

**TGRID-STRAIGHT**  
Straight connector. Extends  
any STANDARD-BAR or  
LIGHT-BAR or can connect  
them together.

# LPLRTGRID

Suspended Ceiling System

# ZALITE

## LIGHT-BAR

---

- 20 W/M
- 1200 delivered lm/M
- 52 lm/W
- 3000K or 4000K
- LM-79 available

Delivered lumens quoted  
Samsung 2835 4000K tested.

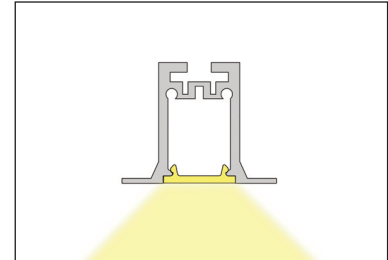

## CONSIDERATIONS WHEN SPECIFYING

---

- 1) FINAL DESIGN DRAWINGS MUST BE APPROVED BY LIGHT FORMS CHINA FACTORY
- 2) WE RECOMMEND TWO SUSPENSIONS PER METER
- 3) PER-BAR CAN BE MOUNTED TO THE WALL OR SUSPENDED  
(CONTACT FACTORY FOR FREE FLOATING SUSPENDED LAYOUTS. ANOTHER SUSPENSION PART IS NEEDED)
- 4) FINAL CONSTRUCTION IS PREWIRED WITH ALL QUICK CONNECTORS AT THE FACTORY ELECTRICAL CONNECTIONS BETWEEN BARS IS MADE FOR EASY INSTALLATION.
- 5) PLEASE PROVIDE EXACT CEILING PANEL SIZE WHEN SPECIFYING.
- 6) ONE BAR MUST PASS THROUGH.  
IN THIS ILLUSTRATION THE LIGHTER SHADED BAR PASSES THROUGH.

THE DARKER BAR RESTS ON THE SHELF OF THE PASS THROUGH BAR.

EITHER STANDARD-BAR OR LIGHT-BAR CAN BE THE PASS-THROUGH BAR OR SERVE AS THE SHORTER BARS THAT REST ON THE SHELF.

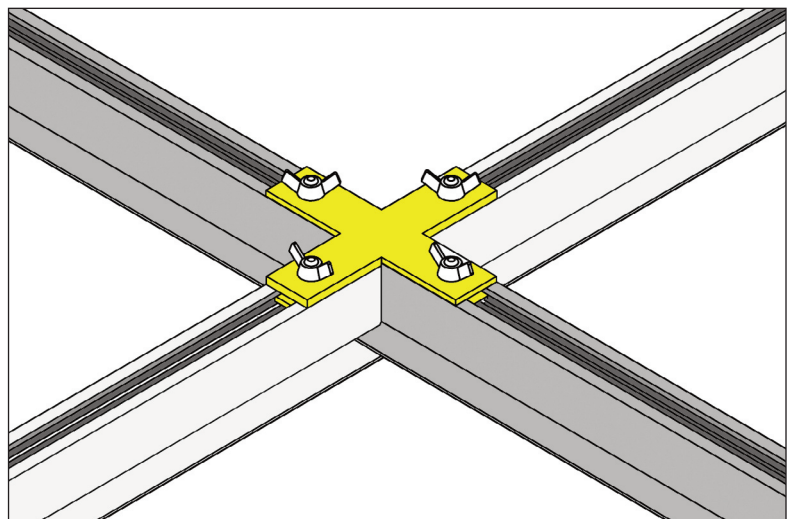

# LPLRTGRID

Suspended Ceiling System

# ZALITE

---

## Housing

100% recyclable, extruded architectural grade T6063 aluminum

---

## Emergency

Luminaires can be wired for emergency circuit and/or emergency battery backup.  
Consult factory for options.

---

## Options

### Mitered Corners

Consult factory for mitered corner angle options.

---

## Finish

Standard finish is "Ultimate" aluminum - a smooth, clean and durable finish achieved from a deep-etch and two step clear anodizing process.

White, Black, Custom powdercoat options also available.



Suspension & Power

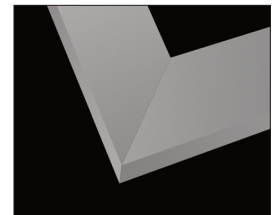

Mitered Corners



WH - WHITE

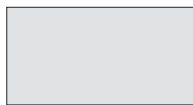

AL - ALUMINUM



BK - BLACK



Custom / \_\_\_\_

Default canopy finish  
is to match fitting color,  
unless otherwise  
specified



ISO 9001:2015